

Quick Start Guide

25.6T Data Center Switch N9200-64DC

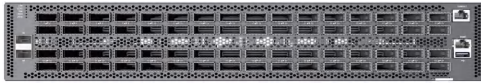

Package Contents



1



2



3



4

1. 25.6T Data Center Switch N9200-64DC
2. Rack mounting kit—1 set of slide rails (includes left and right rails), 1 set of bracket ears (includes left and right ears), 2 stop brackets, 1 bag of screws and accessories

3. HVAC/C20 16A power cord
4. Documentation—*Quick Start Guide* (this document)

Overview

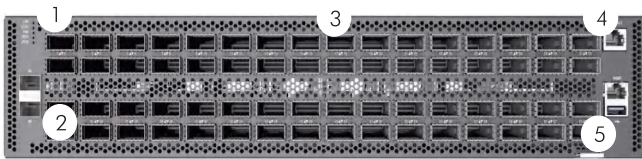

1. System LEDs
2. 2 x 10G SFP+ management ports
3. 64 x 400G QSFP56-DD ports
4. RJ-45 console port
5. 1000BASE-T RJ-45 management port, USB

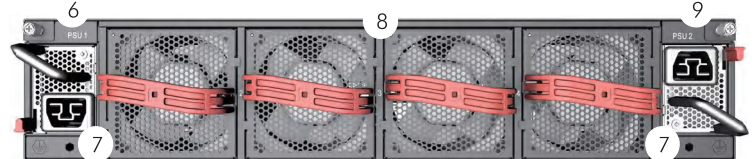

6. PSU 1
7. 2 x grounding screws (maximum torque 10 kgf-cm (8.7 lb-in))
8. 4 x fan trays
9. PSU 2

System/Port LEDs

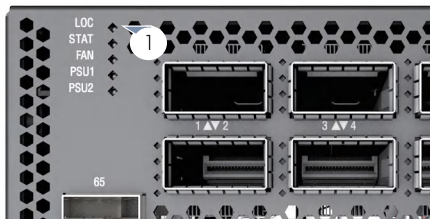

1. **System LEDs**
LOC: Flashing Blue/Amber (switch locator)
STAT: Green (OK), Blinking Green (system booting), Amber (fault)
FAN: Green (OK), Amber (fault), Blinking Amber (too few fans installed)
PSU1/PSU2: Green (OK), Amber (fault)
2. **SFP+ 10G LEDs:** Left: Green (10G link), Amber (1G link)
Right: Green (10G activity), Amber (1G activity)
3. **RJ-45 MGMT LEDs:** Left: Green (1G link), Amber (10/100M link)
Right: Green (1G activity), Amber (10/100M activity)

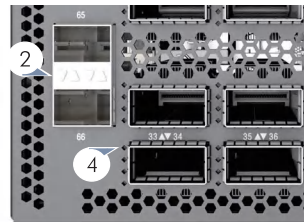

4. **QSFP56-DD LEDs**
400G (1 x 8 lanes 50G PAM4): 1 LED Blue
200G (2 x 4 lanes 50G PAM4): 2 LEDs Cyan
100G (4 x 2 lanes 50G PAM4): 4 LEDs Green
100G (1 x 4 lanes 25G NRZ): 1 LED Green
40G (1 x 4 lanes 10G NRZ): 1 LED Dark Green
50G (2 x 2 lanes 25G NRZ): 2 LEDs Red
25G (4 x 1 lane 25G NRZ): 4 LEDs Orange
10G (4 x 1 lane 10G NRZ): 4 LEDs Yellow

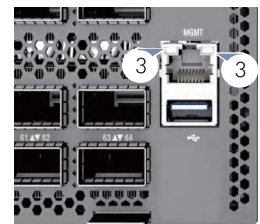

FRU Replacement

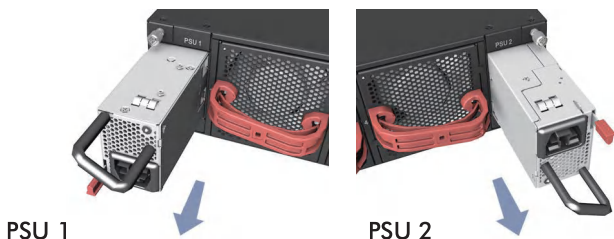

PSU 1

PSU 2

PSU Replacement

1. Remove the power cord.
2. Press the release latch and remove the PSU.
3. Install the replacement PSU in a matching orientation.
(PSU 1 AC socket faces down, and PSU 2 AC socket faces up.)

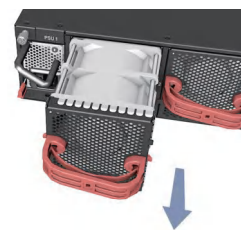

Fan Tray Replacement

1. Pull the handle release latch.
2. Remove fan tray from the chassis.
3. Install replacement fan with matching airflow direction.

Installation



Warning: For a safe and reliable installation, use only the accessories and screws provided with the device. Use of other accessories and screws could result in damage to the unit. Any damages incurred by using unapproved accessories are not covered by the warranty.

Avertissement: Pour une installation sûre et fiable, utilisez uniquement les accessoires et les vis fournies avec l'appareil. L'utilisation d'autres accessoires et vis pourrait endommager l'appareil. Les dommages causés par l'utilisation d'accessoires non approuvés ne sont pas couverts par la garantie.



Note: The drawings in this document are for illustration only and may not match your particular model.

1 Mount the Device



Caution: This device must be installed in a telecommunications room or a server room where only qualified personnel have access.

Attention: Cet appareil doit être installé dans une salle de télécommunications ou une salle de serveurs où seul le personnel qualifié a accès.



1. Secure the left and right ears using 8 of the included M4 countersunk screws (the ears are left and right specific.). Fix the stop brackets using 4 M4 countersunk screws (the stop brackets are L-shaped, with the bent edge up).

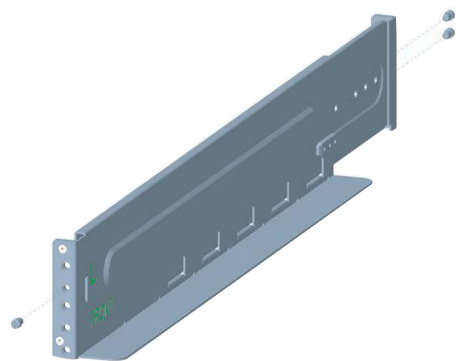

2. According to the size of the rack post square holes, select mounting pins from the accessory screw bag. Install them in the slide rails and tighten them; 1 at the front, 2 at the back. (The illustration shows the installation of the left slide rail. Installation of both sides is the same.)

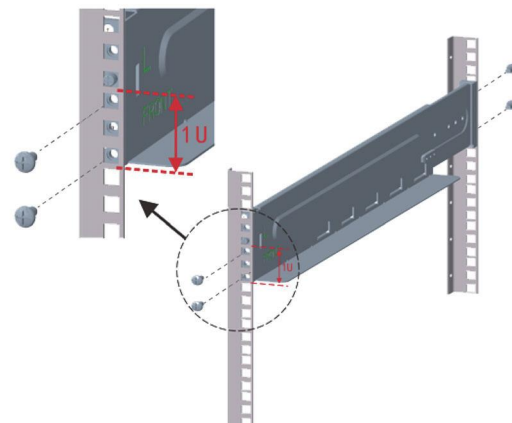

3. Place the slide rails horizontally in the rack. Use 2 M6 panhead screws to secure the front (at the location illustrated), and 2 M6 panhead screws to secure the rear (there are only two screw locations on the rear). (The illustration shows the installation of the left slide rail. Installation of both sides is the same.)



4. Secure the device with two M6 panhead screws.

2 Ground the Device



Verify Rack Ground

Ensure the rack on which the device is to be mounted is properly grounded and in compliance with ETSI ETS 300 253. Verify that there is a good electrical connection to the grounding point on the rack (no paint or isolating surface treatment).

Attach Grounding Wire

Attach a lug (not provided) to a #6 AWG minimum grounding wire (not provided), and connect it to the grounding point on the device rear panel. Then connect the other end of the wire to rack ground.

3 Connect Power

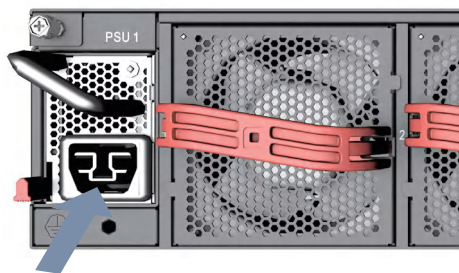

When the input voltage is 200-240 VAC or 240 VDC, install one or two AC PSUs and connect them to the AC power source. When the input voltage is 100-127 VAC, two AC PSUs must be installed and connected to the AC power source.

4 Make Network Connections

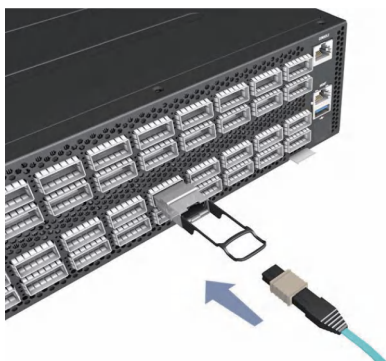

400G QSFP56-DD Ports and 10G SFP+ Ports
 Install transceivers and then connect fiber optic cabling to the transceiver ports. Alternatively, connect DAC or AOC cables directly to the slots.

5 Make Management Connections

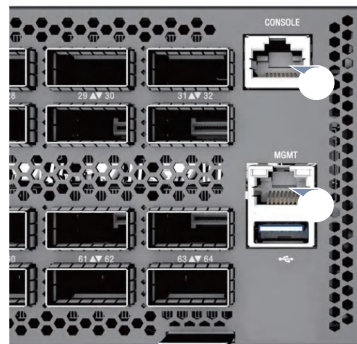

10/100/1000M RJ-45 Management Port
 Connect Cat. 5e or better twisted-pair cable.

RJ-45 Console Port
 Use an RJ-45-to-DB-9 null-modem console cable (not included) to connect to a PC running terminal emulator software. Use a USB-to-male DB-9 adapter cable (not included) for connections to PCs that do not have a DB-9 serial port.

Configure the serial connection: 115200 bps, 8 characters, no parity, one stop bit, 8 data bits, and no flow control.

Console cable pinouts and wiring:

| Device's RJ-45 Console | Null Modem | PC's 9-Pin DTE Port |
|--------------------------|------------|------------------------|
| 6 RXD (receive data) | <----- | 3 TXD (transmit data) |
| 3 TXD (transmit data) | -----> | 2 RXD (receive data) |
| 4,5 SGND (signal ground) | ----- | 5 SGND (signal ground) |

Hardware Specifications

| | |
|-------------------|---|
| Size (WxDxH) | 440 x 649.2 x 87 mm (17.32 x 25.56 x 3.43 in.) |
| Weight | 21.5 kg (47.4 lb), with 2 PSUs and 4 fans installed |
| Temperature | Operating: 0° C to 40° C (32° F to 104° F) Storage: -40° C to 70° C (-40° F to 158° F) |
| Humidity | Operating: 5% to 95% (non-condensing) |
| Power Consumption | 2400 Watts maximum |

AC PSU

| | |
|--------------------|---|
| Input Power Rating | 100–127 VAC, 50/60 Hz, 12 A maximum 200–240 VAC, 50/60 Hz, 15 A maximum HVDC: 240 VDC, 15 A maximum |
|--------------------|---|